

---

Small general frequency converter

# Operating Instruction

---

220V level    0.4kW-3.0kW

400V level    0.4kW-7.5kW

■ Please read this manual carefully and understand the contents for correct installation and use.

■ Please give this manual to the final user and keep it properly.

■ The technical specifications of this product may change without notice.

2R120200907-12.0 Version A

English

Start Date: September 07, 2020

Document Number: XM-H0126

V1.0

## Solemn statement

Thank you for using the frequency converter. Before use, must read this manual carefully, and use it after you are familiar with the safety precautions of this product.

### Safety Precautions:

1. Before wiring, please confirm whether the input power is off.
2. For wiring work, please invite professional electrical engineer to work.
3. The ground terminal must be grounded.
4. After the wiring of the emergency stop circuit is completed, must check whether the action is effective.
5. The output wire of the frequency converter must not be connected to the housing, and the output wire should not be short-circuited.
6. Please confirm whether the voltage of the AC main circuit power supply is consistent with the rated voltage of the frequency converter.
7. Do not perform voltage withstand test on the frequency converter.
8. Please connect the braking resistor according to the wiring diagram.
9. Do not connect the power cord to the output U, V, W terminals.
10. Do not connect the contactor to the output circuit.
11. Be sure to install the protective cover before powering on. When removing the cover, must disconnect the power supply.
12. Select the frequency converter with the reset and retry function, please do not approach the mechanical equipment. It will restart suddenly when the alarm stops.
13. After confirming that the running signal is cut off, the alarm can be reset. If the alarm is reset in the running signal state, the frequency converter may start suddenly.
14. Do not touch the terminals of the frequency converter. There is high voltage on the terminals, which is very dangerous.
15. Do not change the wiring and terminal disassembly during power-on.
16. Cut off the main circuit power supply before inspection and maintenance.
17. Do not modify the frequency converter without authorization.

## 1.Parameters List

Rated data of frequency converter

Model	Power	Power supply	Output current (A)
0.75G1-220V	0.75KW	Single phase alternating 220V-240V	4
1.5G1-220V	1.5KW		7
2.2G1-220V	2.2KW		9.5
0.75G3-380V	0.75KW	Three-phase alternating 380V-440V 50Hz/60Hz	2.5
1.5G3-380V	1.5KW		4.1
2.2G3-380V	2.2KW		5.8
4.0G3-380V	4.0KW		9.4
5.5G3-380V	5.5KW		12.6
7.5G3-380V	7.5KW		16.1

## 2.Product Size

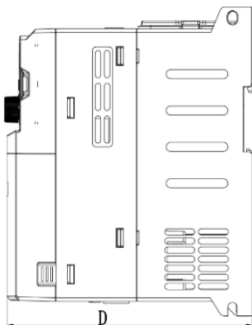
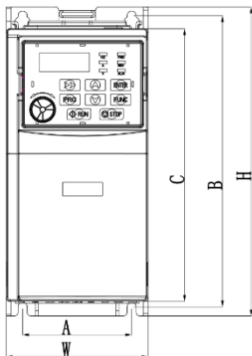

## Product size of frequency converter

	H	W	D	A	B	C
0.75G1-220V	170	78	135	60	160	150
1.5G1-220V	170	78	135	60	160	150
2.2G1-220V	170	78	135	60	160	150
0.75G3-380V	170	78	135	60	160	150
1.5G3-380V	170	78	135	60	160	150
2.2G3-380V	170	78	135	60	160	150
4.0G3-380V	212	95	151	78	200	180
5.5G3-380V	212	95	151	78	200	180
7.5G3-380V						

### 3. Installation and wiring

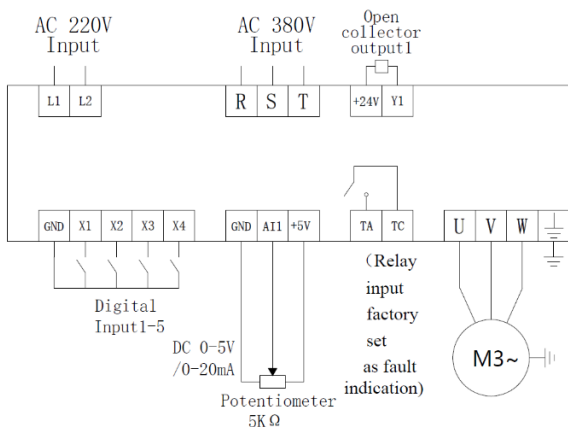

**Usage description of wire terminal**

Terminal	Usage	Setting and Description
R、S、T	Power supply of frequency converter: 380V model connects to R, S, T 220V model connect to R, S or R, T (determined according to terminal label)	The front end of the input power supply of the frequency converter should use an air switch as an overcurrent protection device. If a leakage protection switch is added, in order to prevent the leakage switch from malfunctioning, please choose a device with a sensitivity of 200mA and action time more than 100ms
U、V、W	Frequency converter output which is connected to the motor	In order to reduce the leakage current, the motor connection line should not exceed 50 meters.
	Grounding	The frequency converter must be well grounded.
X1	Digital input X1	Set by parameter F2.13, the factory default is forward
X2	Digital input X2	Set by parameter F2.14, the factory default is reverse
X3	Digital input X3	Set by parameter F2.15, the factory default is the first stage of multi-speed
X4	Digital input X4	Set by parameter F2.16, the factory default is the second stage of multi-speed
GND	Signal common terminal	Zero potential of analog input signal
+24V	Open collector output power supply	+24V,10mA is the largest
+5V	Frequency set the potentiometer power supply	+5V,10mA is the largest
Y1	Open collector output 1	4-20 mA, input impedance: 100 Ω
AI1	Analog input signal	Set by parameter F0.02
TA,TC	Relay output	Set by parameter F0.06 Contact rating: AC 250V/3A DC 24V/2A

## 4. Commissioning

### ① Operation panel and method

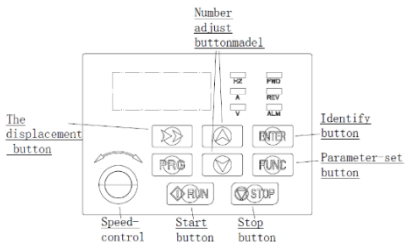

Note: After the frequency converter is powered on, the running panel will display

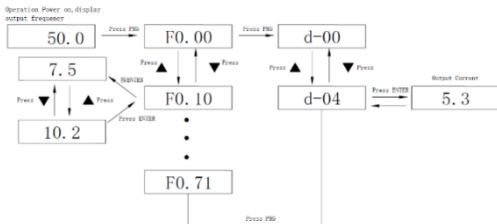

Method of return to the original interface after setting the parameters:

1. After power off, power on again.
2. Select parameter d-00, then press PRG key.
3. Long press the SET button for 3 seconds

### ② Frequency converter running command method setting

The frequency converter operation command mode is set by parameter F0.02: there are three types: start and stop controlled by panel, terminal and communication (optional):

**(1) Panel control start and stop:** (factory default is panel start and stop F0.02=0)

To use the panel to control the start and stop of the frequency converter, press the green button on the panel to start and the red button to stop. The frequency converter will start forward by default, and the forward and reverse must be be set through the input terminals X1-X5 (reverse set to 4).

## (2) Terminal start and stop:

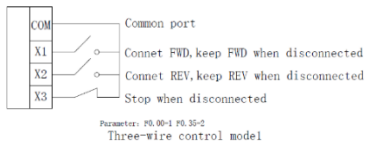
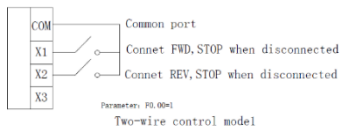

## ③ Selection of frequency converter setting mode

The frequency setting mode of the frequency converter is set by parameter F0.02. When F0.02=0, the operating frequency is set by the potentiometer; when F0.02=2, the operating frequency is inputted by AVI (0-5V can be connected to the potentiometer, J1 line cap jumps to the upper position); when F0.02=2, the operating frequency is inputted by ACI (4-20mA, J1 line cap jumps to the lower position); when F0.02=3, which is controlled by external terminals (the switch amount value is set to frequency increase/decrease).

## 5. Parameters List

Parameter	Name	Factory Default	Predetermined Area	Content
<b>F0 Group- Basic operating parameters</b>				
F0.00	Motor control method	1	0~2	0: VF control 1: Advanced VF control 2: Simple vector control
F0.01	Run command channel selection	0	0~1	0: The panel runs the command 1: The terminal runs the command
F0.02	Frequency setting selection	0	0~5	0: Panel potentiometer 1: Digital setting 1, adjust by operating ▲/▼ keys on the panel 2: AVI simulation given (0~5 V/0~20 mA) 3: Digital setting 2, adjust by terminals UP/DOWN 4: Two-stage speed terminal is connected to the given and run, terminal UP/DOWN adjusts the frequency 5: The second-stage speed terminal triggers the setting and run
F0.03	Operation frequency digital setting	50.0 Hz	0.0~upper limit frequency	The set value is initial value of frequency digital setting
F0.04	Digital frequency control	00	0011	LED ones place: Store at power off 0: Store 1: Do not store LED tens place: Keep state at downtime 0: Keep 1: Do not keep LED hundreds place: reserve Thousands place: reserve



Parameter	Name	Factory Default	Predetermined Area	Content
F0.05	Running direction setting	0	0~1	0: Forward 1: Reverse
F0.06	Maximum output frequency	50.0 Hz	Max {50.0, [F0.06]} ~999.9 Hz	The maximum output frequency is the highest output frequency allowed by the frequency converter and the reference for the acceleration/ deceleration setting.
F0.07	Upper limit frequency	50.0 Hz	Max {0.1, [F0.07]} ~ [F0.05]	The operating frequency cannot exceed this frequency
F0.08	Low limit frequency	0.0 Hz	0.0~Upper limit frequency	The operating frequency cannot be lower than this frequency
F0.09	Acceleration time	Device setting	0.1~999.9 S 0.4~4.0 KW	Time required for the frequency converter to accelerate from zero frequency to the maximum output frequency
F0.10	Deceleration time		7.5 S 5.5~7.5 KW 15.0 S	
F0.11	Torque lift amount	Device setting	0.0~30.0 %	Manual torque lift, and set as 0.0 if you need high torque lift, this value setting is percentage relative to the motor rating voltage
F0.12	Cut-off frequency of torque lift	15.0 Hz	0.0~50.0 Hz	This setting is the lifting cut-off frequency point of manual torque lifting
F0.13	Carrier frequency setting	Device setting	3.0~8.0 kHz 0.4~3.0 kW 4.0 kHz 4.0~7.5 kW 3.0 kHz	For occasions requiring silent operation, the carrier frequency can be appropriately increased to meet the requirements, but increasing the carrier frequency will increase the heat generation of the inverter.

Parameter	Name	Factory Default	Predetermined Area	Content
F0.14	Stop mode	0	0~1	0: Slow down to stop 1: Stop freely
F0.15	Jog frequency setting	10.0 Hz	0.0~Upper limit frequency	Set the jog frequency
F0.16	All input lower limit voltage	0.00V	0.00~5.00 V/0.00~20.00 mA	Set upper and lower limits of All voltage or current
F0.17	All input upper limit voltage	5.00V	0.0~5.0 V	
F0.18	All lower limit corresponding setting	0.0%	-100.0%-100.0%	Set the All upper and lower limits corresponding setting which is corresponding to the percentage of the upper limit frequency [F0.06]
F0.19	All upper limit corresponding setting	100.0 %	0.1~frequency value F2	0: Idle control terminal 1: Forward jog control 2: Reverse jog control 3: Forward control (FWD) 4: Reverse control (REV) 5: Three-wire operation control 6: Free stop control 7: External stop signal input (STOP) 8: External reset signal input (RST) 9: External fault normally open input 10: Frequency up command (UP) 11: Frequency down command (DOWN) 13: Multi-speed option S1 14: Multi-speed option S2 15: Multi-speed option S3 16: Run command channel forced to be terminal 17: Reserve 18: Reserve 19: Frequency switching to AVI 20: Frequency switching to digital frequency 1
F0.20	Input Terminal X1 function	3	0~23	
F0.21	Input Terminal X2 function	4	0~23	
F0.22	Input Terminal X3 function	7	0~23	
F0.23	Input Terminal X4 function	0	0~23	

Parameter	Name	Factory Default	Predetermined Area	Content
F0.24	Reserve	0	-	21: Frequency switching to digital frequency 2 22: Reserve 23: Relay 24: Select speed 1 and run 25: Select speed 2 and run 26: Multi-speed shutdown (only valid for functions 24 and 25)
F0.25	Y1 output setting	0	0~20	0: Idle 1: The frequency converter is running
F0.26	R output setting	2	0~20	2: Frequency converter failure 3: Input setting 23 is valid 4: Frequency/speed arrival signal (FAR) 5: Frequency/speed level detection signal (FDT) 6: Frequency converter overload pre-alarm level 7: Frequency converter overload pre-alarm delay ~20: reserved
F0.27	R Closing delay	0.0s	0.0~255.0s	The delay between the relay R state has changes to output also has change
F0.28	R Disconnection delay			
F0.29	Frequency reaches the FAR detection range	5.0Hz	0.0Hz~15.0Hz	The output frequency is within the positive and negative detection width of the set frequency, and the terminal outputs a valid signal (low level)
F0.30	FDT level setting value	10.0 Hz	0.0Hz~Z~frequency upper limit	
F0.31	FDT lagged value	1.0 Hz	0.0~30.0 Hz	

Parameter	Name	Factory Default	Predetermined Area	Content
F0.32	UP/DOWN adjusting frequency rate	10.0	0.0~ 50.0 Hz/S	Set the UP/DOWN Adjusting frequency rate
F0.33	Terminal electrical level selection	0	0~1FH	0: Electrical level mode 1: Trigger mode
F0.34	Terminal input filter coefficient	10	0~9999	Set the terminal input filter coefficient
F0.35	Terminal input logic	0	0~1FH	Set terminal input logical
F0.36	FWD/REV terminal control mode	0	0 ~ 3	0: Two-wire control mode 1 1: Two-wire control mode 2 2: Three-wire control mode 1 3: Three-wire control mode 2
F0.37	Terminal function detection selection at power-on	0	0 ~ 1	0: Terminal run command is invalid at power-on 1: Terminal run command is valid at power-on
F0.38	Multi-speed frequency 1	5.0 Hz	Negative upper limit frequency ~ Upper limit frequency	Set the frequency in velocity period 1
F0.39	Multi-speed frequency 2	10.0 Hz	Negative upper limit frequency ~ Upper limit frequency	Set the frequency in velocity period 2
F0.40	Multi-speed frequency 3	15.0 Hz	Negative upper limit frequency ~ Upper limit frequency	Set the frequency in velocity period 3

Parameter	Name	Factor Default	Predetermined Area	Content
F0.41	Multi-speed frequency 4	25.0 Hz	Negative upper limit frequency ~ Upper limit frequency	Set the frequency in velocity period 4
F0.42	Multi-speed frequency 5	35.0 Hz	Negative upper limit frequency ~ Upper limit frequency	Set the frequency in velocity period 5
F0.43	Multi-speed frequency 6	45 Hz	Negative upper limit frequency ~ Upper limit frequency	Set the frequency in velocity period 6
F0.44	Multi-speed frequency 7	50.0 Hz	Negative upper limit frequency ~ Upper limit frequency	Set the frequency in velocity period 7
F0.45	Acceleration time 2	10.0 s	0.1~999.9 s 0.4~4.0 kW 10.0 s 5.5~7.5 Kw 15.0 s	Set acceleration and deceleration time 2
F0.46	Deceleration time 2			

Parameter	Name	Factor Default	Predefined Area	Content
F0.47	Jog acceleration time	Device setting	0.1~255.0 s 0.4~4.0KW 10.0S 5.5~22KW 15.0S	Set the jog acceleration and deceleration time
F0.48	Jog deceleration time			
F0.49	Motor rated voltage	Device setting	0~500V: 380V 0~250V: 220V	Motor parameter setting
F0.50	Motor rated frequency	50.0 Hz	1.0~999.9 Hz	
F0.51	Motor rated speed	Device setting	0~60000 rpm	
F0.52	Motor rated current	Device setting	0.1~999.9 A	
F0.53	Motor no-load current	Device setting	0.1~999.9 A	
F0.54	Motor stator resistance	Device setting	0.001~20.000Ω	
F0.55	Slip compensation selection	0	0~1	0 : Invalid 1: Valid
F0.56	Motor overload protection coefficient	100%	0%~200%	The motor overload protection coefficient is the percentage of the motor rated current value to the rated output current of the frequency converter.
F0.57	Undervoltage protection level	180/ 360V	50-280/ 50-480V	This function code specifies the lower limit voltage allowed by the DC bus when the frequency converter is working normally

Parameter	Name	Factory Default	Predefined Area	Content
F0.58	Deceleration voltage limiting coefficient	1	0: shut down, 1~255	This parameter is used to adjust the ability of the frequency converter to suppress overvoltage during deceleration.
F0.59	Overvoltage limit level	375/790V	350-400/ 660-850V	The overvoltage limit level defines the operating voltage for overvoltage stall protection
F0.60	Acceleration current limiting coefficient	10	0: shut down, 1~99	This parameter is used to adjust the ability of the frequency converter to suppress overcurrent during acceleration.
F0.61	Constant speed current limiting coefficient	0	0: shut down, 1~10	This parameter is used to adjust the ability of the frequency converter to suppress overcurrent during constant speed.
F0.62	Current limit level	180%	50% ~250%	The current limit level defines the current threshold for the automatic current limit action, and its set value is relative to the percentage of rated current of the frequency converter.
F0.63	Parameter initialization	0	0~1	0: No operation The frequency converter is in normal parameter reading and writing status. Function code setting value.
F0.63	Parameter initialization	0	0~1	Whether it can be changed is related to the setting status of the user password and the current working status of the frequency converter. 1: Restore factory settings All user parameters are restored to factory settings according to the model.

Parameter	Name	Factor Default	Predetermined Area	Content
F0.64	Main interface display selection	10	00~FFH	<p>which means select the output current d-04, and the default display item of the main monitoring interface is the current output current value during operation.</p> <p>LED's tens place: Selection of monitoring parameter during downtime.</p> <p>You can change the monitoring items of main interface display by changing the setting value of this function code. For example, set the tens place of F0.62 equal to 8, which means select the module temperature d-08, and the default display item of the main monitoring interface is the current module temperature during downtime.</p> <p>LED hundreds place: Reserve LED thousands place: Reserve</p>
F0.65	Auxiliary display selection	34	00~FFH	<p>LED ones place: monitoring parameter selection at operating status</p> <p>LED tens place: monitoring parameter selection at down state</p> <p>Hundreds of LEDs: reserved LED Thousands: Reserved</p>
F0.66	Voltage compensation	0	0-1	<p>0: Invalid 1: Valid</p>



Parameter	Name	Factor Default	Predetermined Area	Content
F0.67	Output phase loss protection detection coefficient	2.00	0.00~20.00	When the ratio of the maximum value to the minimum value of the three-phase output current is greater than this coefficient, and the duration exceeds 6 seconds, the frequency converter reports the output current unbalance fault ETUN
F0.68	Frequency converter overload pre-alarm level	120%	0~150%	The current threshold of the frequency converter overload pre-alarm action, the set value is relative to the rated current of the frequency converter.
F0.69	Frequency converter overload pre-alarm delay	5.0 s	0.0~15.0s	The delay time between the output current of the frequency converter is continuously larger than the overload pre-alarm level (F0.68) and output overload pre-alarm signals.
F0.70	Motor tuning	0	0~1	0: Invalid 1: Statical tuning
F0.71	User password	0	0~9999	Set any non-zero number and wait 3 minutes or power down before it takes effect
F0.72	JOG keys setting	0	0~3	0: JOG 1: Forward and reverse switch 2: Clear ▲/▼ key frequency setting 3: Run in reverse (at this time, the default Run key is forward)
F0.73	PID Functional Setting	0	00~12	LED one's place: PID sleep mode 0: disabled 1: Normal hibernation 2: Disturbance sleep Same as the parameter setting

Parameter	Name	Factor Default	Preetermined Area	Content
				when the sleep mode is selected as 0, if the PID feedback value is within the range of the F0.85 setting value, the sleep delay time will be maintained and the disturbance sleep will be entered. When the feedback value is less than the wake-up threshold(PID polarity is positive), immediately wake up LED ten's place: PID feedback disconnection selection 0: disabled 1: enabled LED hundred's place: reserved LED thousand's place: reserved
F0.74	Pressure setting	0.00	0.00(MPa、Kg) ~ Sensor range	Use the keyboard to set the given amount of PID control
F0.75	Sensor range	10.00	0.00 ~ 90.00 (MPa、Kg)	Set the maximum range of sensor
F0.76	Proportional gain P	2.00	0.01 ~ 5.00	The adjustment speed of PID is set by two parameters, Proportional gain P and Integration Time Ti. If you want a higher speed, you should increase the proportional gain P and decrease the integration Time; if you want a lower speed, you should decrease the proportional gain P and increase the integration time. Under general conditions, we do not set the derivative time.

Parameter	Name	Factor Default	Predefined Area	Content
F0.77	Integral time Ti	6.0s	0.1~50.0s	
F0.78	Threshold value of sleeping	100.0%	0.0~150.0%	If the actual feedback value is greater than the set value and the inverter output frequency reaches the sleep frequency, The inverter will turn to sleeping state after the delay time defined by F0.79 (ie zero speed operation); The value is the percentage of the PID set value.
F0.79	Delay time of sleep	100.0s	0.0~999.9	Set the time-delay of sleeping
F0.80	Threshold value of awaking	90.0%	0.0~150.0%	If the feedback value is less than the set value, the inverter will turn to sleeping state after waiting for the delay time defined by F0.81; This value is a percentage of the PID set value.
F0.81	Delay time of awaking	1.0s	0.0~999.9	Set the time-delay of awaking
F0.82	Feedback channel gain	1.00	0.01~10.0	When the feedback channel is not consistent with the setting channel, the function can be used to adjust the signal of feedback channel.

Parameter	Name	Factory Default	Predetermined Area	Content
F0.83	Feedback disconnection detection value	0.0%	0.0~100.0%	This value is percentage of PID given amount. When the PID feedback value continues to be less than the feedback disconnection detection value. The inverter will make the corresponding protection action. When F0.83=0.0%, this value is invalid.
F0.84	Feedback disconnection detection time	10.0s	0.1~999.9	When the feedback disconnection occurs, the time-delay before the protective action.
F0.85	Deviation limit of feedback when entering	0.5%	0.0~20.0%	The function parameter is only effective to the disturbance sleeping mode.
F0.86	Sleep frequency	0.0	0.0~pper limit freq.	Set sleep frequency

#### F1 Group- Basic operating parameters

F1.00	Manufacturer password		1~9999	System setting special password
-------	-----------------------	--	--------	---------------------------------

#### Group d - Monitoring parameter group

Parameter	Name	Range	Minimum unit
d-00	Output frequency (Hz) setting	0.0~999.9Hz	0.1Hz
d-01	Set frequency (Hz)	0.0~999.9Hz	0.1Hz
d-02	Output voltage (V)	0~999V	1V
d-03	Bus voltage (V)	0~999V	1V

d-04	Output current (A)	0.0~999.9A	0.1A
d-05	Terminal input status	0~1FH	0
d-06	Terminal output status	0~FH	0
d-07	All analog input (V/mA)	0.00~5.00V/20.00mA	0.00
d-08	Module temperature ( °C)	0.0~132.3°C	0.0
d-09	Software upgrade date (year)	2010~2026	2020
d-10	Software upgrade date (month, day)	0~1231	0709
d-11	Last fault code	0~14	0
d-12	Current fault code	0~14	0
d-13	Output frequency (Hz) in the most recent fault	0.0~999.9Hz	0.0 Hz
d-14	Output current (A) in the most recent fault	0.0~999.9A	0.0 V
d-15	Bus voltage (V) in the most recent fault	0~999V	0V
d-16	Software version	1.00~99.99	1.00
d-17	Power model	0.10~99.99 kW	Device
d-18	Motor speed (rpm)	0~60000 rpm	Device setting

<b>Group E - Fault code</b>			
<b>Fault code</b>	<b>Name</b>	<b>Possible reason of failure</b>	<b>Troubleshooting</b>
EOC1	Overcurrent during acceleration	Acceleration time is too short	Increase the acceleration time
		The power of frequency converter is too small	Use a frequency converter with a large power level
		Improper setting of V/F curve or torque boost	Adjust the V/F curve or torque boost
EOC2	Overcurrent during deceleration	Acceleration time is too short	Increase the acceleration time
		The power of frequency converter is too small	Use a frequency converter with a large power level

<b>Fault code</b>	<b>Name</b>	<b>Possible reason of failure</b>	<b>Troubleshooting</b>
EOC3	Overcurrent during constant speed operation	Low grid voltage	Check input power
		Load become mutational or abnormal	Check load or reduce load change
		The power of frequency converter is too small	Use a frequency converter with a large power level
EHU 1	Overvoltage during acceleration	Abnormal input voltage	Check input power
		Restart the rotating motor	Set to start after DC braking
EHU 2	Overvoltage during deceleration	Deceleration time is too short	Increase deceleration time
		Abnormal input voltage	Check input power supply
EHU 3	Overvoltage during constant speed operation	Abnormal input voltage	Check input power supply
EHU 4	Overvoltage during shut-down	Abnormal input voltage	Check the power voltage supply
ELU0	Undervoltage in operation	-	-
E-OH1	Heat sink overheating	Ambient temperature is too high	Reduce ambient temperature
		Fan damage	Replace the fan
		Air duct blockage	Dredge the air duct
EOL1	Frequency converter	Improper setting of V/F curve or torque boost	Adjust the V/F curve or torque
		Grid voltage is too low	Check the grid voltage

	overload	Acceleration time is too short	Increase acceleration time
		Motor overload	Use a frequency converter with a large power level
EOL2	Motor overload	Improper setting of V/F curve or torque boost	Adjust the V/F curve or torque boost
		Grid voltage is too low	Check grid voltage
		Motor stalled or the mutation of load is too large	Check the load
		Motor overload protection factor setting is incorrect	Set the motor overload protection coefficient Correctly
E-EF	External device failure	External device fault input terminal is closed	Disconnect the external device fault input terminal and clear the fault (Pay attention to checking the cause)
EPID	PID Feedback disconnection	PID feedback circuit is loose	Check feedback connection
		The feedback amount is less than the disconnection detection value	Adjust the detection input threshold
ECCF	Current detection fault	Current sampling circuit failure	Ask the manufacturer for service
		Auxiliary power failure	
EEEP	EEPROM read-write error	EEPROM failure	Ask the manufacturer for service
E-LP	Output phase loss		

## 6.Applications

### (1) constant pressure water supply control by frequency converter

A: Electric contact pressure gauge control (the simplest control method)

Use the electric contact pressure gauge to control the water pressure. You only need to connect 2 wires, one from the green needle and the other from the black needle, respectively connected to the upper 2 of the 3 terminals of the electric contact pressure gauge (some electric contact table may be different). When the water pressure is low, the black needle is underneath the green needle, and the frequency converter is in the acceleration start state. When the water pressure is high, the black needle is on the top of green needle, and the frequency converter is in the deceleration stop state. Very simple and easy to maintain.

For this frequency converter, the debugging steps are as follows:

- ① Connect the two wires from the electric contact pressure gauge, one wire of the start signals to X1, and the other wire to GND (do not need to distinguish between positive and negative pole, please connect the start signal after setting all parameters).
- ② Set parameter F0.01=1 to select external terminal to start control.
- ③ Turn up the speed control knob on the panel to the maximum.
- ④ Frequency converter parameter setting: F0.20=3 (default value), F0.09=60, F0.10=60, F0.37 =1

It can start automatically after power on. If it does not start, you can use a wire to directly connect X1 and GND to see if it starts. If it still fails, it means there is a problem with the internal settings of the frequency converter. If it can be started, it means the external electric contact meter or circuit problem. You can check whether the two wires on the electric contact are connected. If the black needle is lower than the green needle, it should be connected, and if the black needle is higher than the green needle, it should be disconnected.



### **(2) Two speed setting mode control**

Equipment requirements: use the potentiometer knob to adjust the speed during forward rotation, and use multi-speed low-speed operation during reverse rotation.

①Parameter setting: F0.02=1, F0.03=3, F1.17=10 (reverse running speed 10HZ)

②Connection: 3 wires of the potentiometer are connected to GND, AVI, +10V, the forward rotation signal is connected to X1 and GND, the reverse signal is connected to X2, GND, and X2 and X3 are short-circuited (set the frequency at the same time when reverse Select the setting value of multi-speed 1).

### **(3) Jog control**

Equipment that needs jog control:

① Parameter setting: F0.02=1, F2.15=1 (forward jog), F2.16=2 (reverse jog), forward jog frequency is given by parameter F1.09, reverse point The dynamic frequency is given by parameter F1.10. The jog acceleration time is set by parameter F1.11, and the jog deceleration time is set by parameter F1.12.

② Wiring: the forward jog signal is connected to GND and X3, and the reverse jog signal is connected to GND and X4.

### **(4) Torque is insufficient when running at low speed (rotation is weak)**

Adjust parameter F0.14, gradually adjust from small to large. Don't adjust it too large at the beginning. If it is adjusted too large, it may report OC overcurrent fault.

Adjust parameter F0.15, which is the cutoff frequency of torque boost.

# Service delivers value, quality creates glory

## **To customers:**

Thank you for using our products. In order to ensure that you get the best after-sales service from our company, please read the following terms carefully and do the relevant matters.

### **1. Product warranty scope**

Any failures that occur under normal use according to the requirements of use are covered by the warranty.

### **2. Product warranty period**

The warranty period of this product is within twelve months from the date of delivery. Long-term technical support services will be implemented after the warranty period.

### **3. Non-warranty coverage**

Any damage caused by human factors, natural disasters, water ingress, external force damage, harsh environment, etc. that violate the requirements of use, as well as unauthorized disassembly, modification and maintenance of the frequency converter, shall be deemed to automatically waive the warranty service.

### **4. Purchase products from middlemen**

Anyone who purchases products from distributors or agents should contact the distributor or agent if the product fails.

Please keep this manual properly in case you need it.